

STAINLESS STEEL INDUSTRIAL RANGE  
S40 SIZE WITH SINGLE PHASE MOTOR

Printed from  
**JABSCOshop**

- a division of  
**CLEGHORN WARING**

tel: +44(0)870 738001  
fax: +44(0)870 738002  
mail@jabscoshop.co.uk  
www.jabscoshop.co.uk

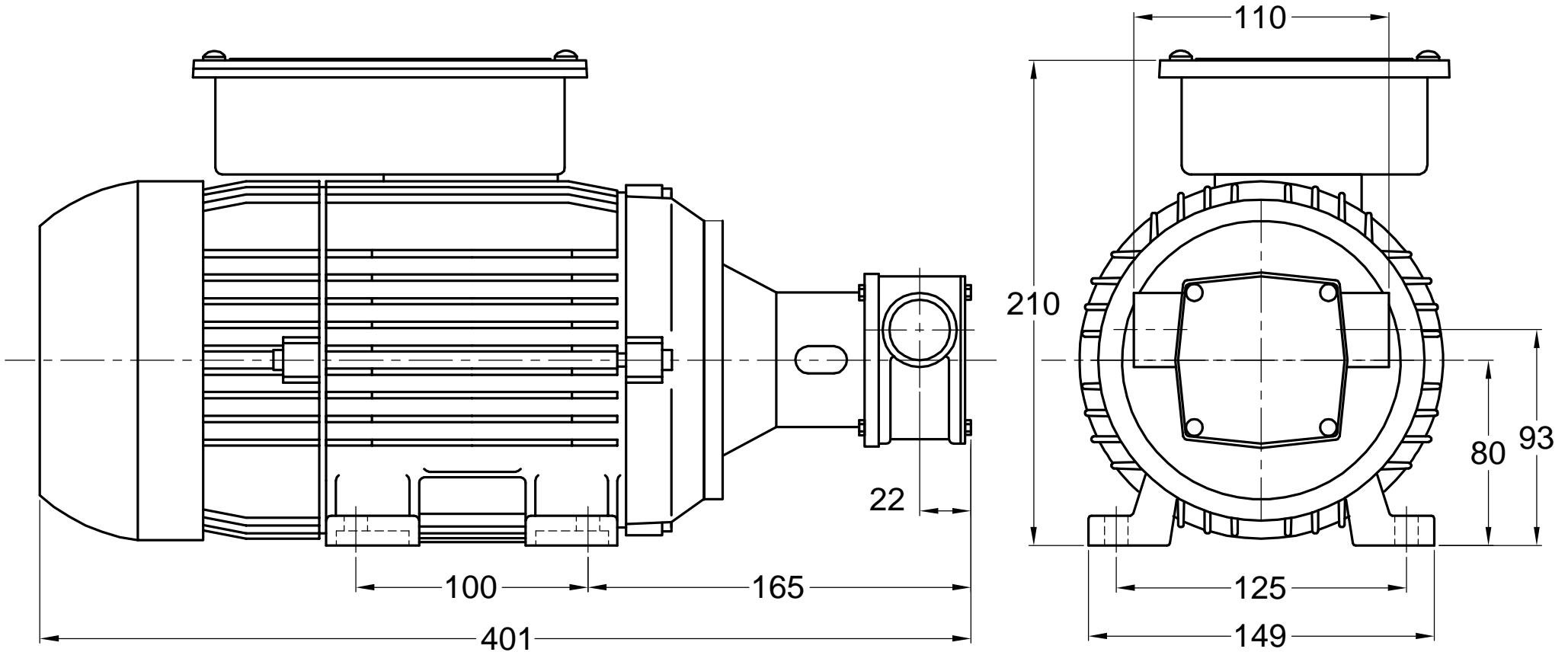

MOTOR DIMENSIONS MAY VARY ACCORDING TO MAKE AND TYPE FITTED  
dimensions in mm